



# CONTENT

MERSEN ANTICORROSION EQUIPMENT	p.2
A COMPLETE RANGE OF BURSTING DISCS	p.3
REQUIRED INFORMATION	p.5
CHOOSING A BURSTING DISC	p.6
THERMAL INSULATION DEVICE	p.7
TRACEABILITY, MARKINGS AND CODING	p.8
TECHNICAL INFORMATION	p.9
BURSTING DISCS IN GRAPHILOR®3 SERIES 1	p.10
BURSTING DISCS IN GRAPHILOR®3 SERIES 2	p.11
BURSTING DISCS IN GRAPHILOR®3 SERIES 3	p.12
BURSTING DISCS IN GRAPHILOR®3 SERIES 4	p.13
BURSTING DISCS IN GRAPHILOR®3 SERIES 5	p.14
BURSTING DISCS IN GRAPHILOR®3 SERIES 6	p.15
BURSTING DISCS IN GRAPHILOR®3 SERIES 7	p.16
BURSTING DISCS IN GRAPHILOR®3 SERIES 8	p.17

# MERSEN ANTICORROSION EQUIPMENT















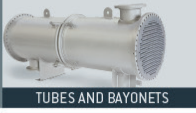

The Mersen AntiCorrosion Equipment activity is internationally recognized for its expertise in the design and manufacture of process equipment, manufactured from corrosion resistant materials (graphite, silicon carbide, tantalum, zirconium, PTFE). Mersen also has an in-depth knowledge of the process technologies requiring our AntiCorrosion Equipment and can provide offers from the basic equipment only, up to skid-mounted turn-key process packages.

A GRAPHILOR® 3 bursting disc is a safety component intended to protect against accidental overpressure or vacuum by instantaneous opening at the specific burst pressure (PRS).

## THE GRAPHILOR® 3

GRAPHILOR® 3 is a unique material : resistant to thermal shock, having very high resistance to corrosion, chemically inert, reliable and economical.

Depending on the series, bursting discs are manufactured from both impregnated and unimpregnated GRAPHILOR® 3, or GRAPHILOR® 3 N. GRAPHILOR® 3 is particularly suitable for the manufacturing of bursting discs, providing an excellent resistance to corrosion with a thin membrane.

	HEAT EXCHANGERS	REACTORS, VESSELS AND COLUMNS	PIPING BELLOWS ACCESSORIES	PROCESS TECHNOLOGIES														
GRAPHITE	 BLOCKS, CUBIC AND TUBES		 RUPTURE DISCS	 <b>FEEDSTOCK</b> <table border="1"> <tr> <td>H<sub>2</sub>SO<sub>4</sub></td> <td>Br<sub>2</sub></td> </tr> <tr> <td>HCl</td> <td>P<sub>2</sub>O<sub>5</sub></td> </tr> <tr> <td>Cl<sub>2</sub></td> <td>FeCl<sub>3</sub></td> </tr> <tr> <td>HBr</td> <td>Brine</td> </tr> <tr> <td>Flue Gas</td> <td></td> </tr> </table>	H <sub>2</sub> SO <sub>4</sub>	Br <sub>2</sub>	HCl	P <sub>2</sub> O <sub>5</sub>	Cl <sub>2</sub>	FeCl <sub>3</sub>	HBr	Brine	Flue Gas					
H <sub>2</sub> SO <sub>4</sub>	Br <sub>2</sub>																	
HCl	P <sub>2</sub> O <sub>5</sub>																	
Cl <sub>2</sub>	FeCl <sub>3</sub>																	
HBr	Brine																	
Flue Gas																		
SILICON CARBIDE	 BLOCKS AND TUBES																	
TANTALUM	 TUBES AND BAYONETS		 TANTALUM SMALL PARTS															
ZIRCONIUM	 HEAT EXCHANGERS		 RUPTURE DISCS															
TITANIUM	 HEAT EXCHANGERS		 PIPING AND BELLOWS															
NICKEL ALLOYS	 HEAT EXCHANGERS																	
PTFE			 PIPING AND BELLOWS															
<b>AFTER-SALES SERVICE</b>				<b>PROCESS FUNCTIONS</b> <table border="1"> <tr> <td>Gas cleaning / Vent treatment</td> <td>Distillation/ Desorption/Stripping</td> </tr> <tr> <td>Organic removal</td> <td>Absorption</td> </tr> <tr> <td>Production</td> <td>Burner</td> </tr> <tr> <td>Temp. Control</td> <td>Concentration</td> </tr> <tr> <td>Vaporizer</td> <td>Dilution</td> </tr> <tr> <td>Vacuum system</td> <td>Gas Drying</td> </tr> <tr> <td>Inorganic removal</td> <td></td> </tr> </table>	Gas cleaning / Vent treatment	Distillation/ Desorption/Stripping	Organic removal	Absorption	Production	Burner	Temp. Control	Concentration	Vaporizer	Dilution	Vacuum system	Gas Drying	Inorganic removal	
Gas cleaning / Vent treatment	Distillation/ Desorption/Stripping																	
Organic removal	Absorption																	
Production	Burner																	
Temp. Control	Concentration																	
Vaporizer	Dilution																	
Vacuum system	Gas Drying																	
Inorganic removal																		

# A COMPLETE RANGE OF BURSTING DISCS

TYPES OF PRODUCTS	SERIES	AREAS OF USES	MATERIALS USED	OPTIONS	
DISCS WITH REMOVABLE MEMBRANES	1	LOW PRESSURE	<ul style="list-style-type: none"> <li>■ GRAPHILOR® 3 OR STAINLESS STEEL (SUPPORT)</li> <li>■ GRAPHILOR® 3 UN-IMPREGNATED (MEMBRANES)</li> <li>■ EXPANDED GRAPHITE (MEMBRANE GASKETS)</li> </ul>	<ul style="list-style-type: none"> <li>■ STAINLESS STEEL SUPPORT</li> <li>■ BURST DETECTOR</li> <li>■ THERMAL INSULATION DEVICE</li> <li>■ VACUUM SUPPORT optional for series 2 (included in series 1).</li> </ul>	
	2	MEDIUM PRESSURE	<ul style="list-style-type: none"> <li>■ GRAPHILOR® 3 OR STAINLESS STEEL (SUPPORT)</li> <li>■ GRAPHILOR® 3 NOT IMPREGNATED (MEMBRANES)</li> <li>■ EXPANDED GRAPHITE (MEMBRANE GASKETS)</li> </ul>		
SINGLE-PIECE DISCS	3	MEDIUM PRESSURE	<ul style="list-style-type: none"> <li>■ GRAPHILOR® 3 IMPREGNATED (DISC)</li> <li>■ EXPANDED GRAPHITE (GASKETS)</li> </ul>	<ul style="list-style-type: none"> <li>■ THERMAL INSULATION DEVICE</li> <li>■ VACUUM SUPPORT FOR SERIES 4</li> <li>■ BURST DETECTOR</li> <li>■ SPARK GUARD BASKET</li> </ul>	
	4	MEDIUM PRESSURE			
	5	HIGH PRESSURE			
	6	MEDIUM PRESSURE			<ul style="list-style-type: none"> <li>■ GRAPHILOR® 3 UN-IMPREGNATED (DISC)</li> <li>■ EXPANDED GRAPHITE (GASKETS)</li> </ul>
	8	MEDIUM PRESSURE			<ul style="list-style-type: none"> <li>■ GRAPHILOR® 3 IMPREGNATED (DISC)</li> <li>■ EXPANDED GRAPHITE (GASKETS)</li> </ul>
BURST PLUGS	7	LOW FLOW RATE	<ul style="list-style-type: none"> <li>■ GRAPHILOR® 3 IMPREGNATED (DISC)</li> <li>■ EXPANDED GRAPHITE (GASKETS)</li> </ul>	<ul style="list-style-type: none"> <li>■ BRASS OR STAINLESS STEEL SUPPORT</li> </ul>	



**SERIES 1**



**SERIES 2**



**SERIES 3**



**SERIES 4**



**SERIES 5**



**SERIES 6**



**SERIES 7**



**SERIES 8**



# REQUIRED INFORMATION

Graphite bursting discs are designed in accordance with the European 2014/68/UE (ex-97/23/CE), category IV part B and D of gases from the group I.

The tests are carried out in accordance with European EN ISO 41 26-2 standard.  
Upon request, the disc relief diameter ( $D_B$ ) can be estimated according to BS 2915 standard.

The European EN ISO 4126-2 standard lists all the information the purchaser must provide to the manufacturer. It concerns the following items :

## APPLICATION :

- Nature of the equipment to be protected,
- Planned utilization for the disc (primary or secondary relief device, valve protection ... etc),
- Nature of the fluid in contact,
- Operating conditions which the disc can be subject to: (minimum and maximum) temperature, (normal and maximum) pressure, back-pressure, vacuum... etc.

## DISC OPERATION :

- Specified burst pressure (PRS\*) at a specified temperature ( $T_g$ ),
- Minimum relief section ( $A_B$ ) or diameter ( $D_B$ ) of the disc,
- Required operating ratio ( $K_s$ ) (=operating pressure (bar) / PRS minimum limit (bar)).  
(the ratio is  $\leq 0.8$  for Mersen bursting discs)

## INSTALLATION :

- Coupling type

## THE SPECIAL FEATURES :

- Thermal insulation system (TIS) required,
- Vacuum grid required,
- Corrosion protection coating required,
- Burst detector required,
- Shielding cage required.

(\*) PRS given with its tolerance (in %) or with the upper and lower limits of the bursting pressure. PRS is the value of the differential pressure between the upstream side and the downstream side of the disc upon bursting.



# CHOOSING A BURSTING DISC

THE FOLLOWING PARAMETERS MUST BE KNOWN WHEN SELECTING A BURSTING DISC :

- The specified burst pressure (PRS)
- The specified burst temperature ( $T_s$ )
- The discharge diameter ( $D_B$ )
- The operating ratio ( $K_s$ )
- The pressure and vacuum conditions
- The nature of the material in contact with the bursting disc

TYPES OF PRODUCTS	SERIES	DISCHARGE DIAMETER ( $D_B$ )		PRS IN BARG*	PRS TOLERANCE	OPERATING RANGE (°C)**	$K_s$ MAX
		mm	Inches				
DISCS WITH REMOVABLE MEMBRANES	1	50 to 600	2 to 24	0,07 to 0,34	± 25%	-50 to + 165	0,8
	2	25 to 600	1 to 24	0,35 to 30	± 10%	-50 to + 165	0,8
SINGLE-PIECE DISCS	3	25 to 600	1 to 24	0,08 to 40	± 10%	-50 to + 165	0,8
	4	25 to 600	1 to 24	0,35 to 40	± 10%	-50 to + 165	0,8
	5	25 to 600	1 to 24	1,2 to 100	± 10%	-50 to + 165	0,8
	6	25 to 600	1 to 24	0,1 to 35	± 15%	-50 to + 165	0,8
	8	25 to 600	1 to 24	0,08 to 40	± 15%	-50 to + 165	0,8
RUPTURE PLUGS	7	12,7 19	1/2 3/4	1,4 to 80	± 15%	-50 to + 165	0,8

(\*) The specified burst pressure is calibrated at 20°C

(\*\*) Utilization up to 350°C upon special request

# THERMAL INSULATION DEVICE

## HIGH TEMPERATURE USE

When the operating temperature exceeds 165°C, a thermal insulation system must be provided. The thermal insulation system makes it possible to maintain the temperature of the bursting disc at 20°C.

### OPERATING TEMPERATURE LIMITS :

- + 350°C in gas phase
- + 250°C in liquid phase

### MATERIALS :

- Graphilor® 3 ring and retaining grid
- Carbon fiber insulation packing
- Expanded graphite gaskets

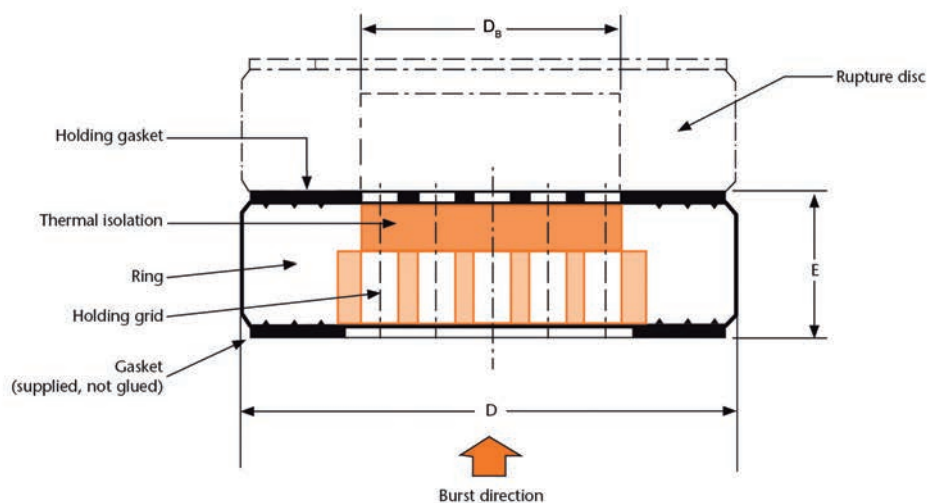

DISCHARGE DIAMETER D <sub>B</sub> (nominal)		OUTER DIAMETER D (mm)		ETHICKNESS	DISCHARGE CROSS SECTION (%)	APPROXIMATE WEIGHT (Kg)		GASKET OD/ID (mm) Thickness = 2mm	
mm	inches	SERIES 1-2-3-4-6	SERIES 5			SERIES 1-2-3-4-6	SERIES 5	SERIES 1-2-3-4-6	SERIES 5
25	1	65	100	22	50	0,09	0,28	63/27	98/27
40	1 ½	80	130	23	52	0,15	0,5	78/42	128/42
50	2	100	160	24	56	0,22	0,77	98/52	158/52
65	2 ½	115	190	26	53	0,3	1,2	113/67	188/67
80	3	130	190	27	52	0,4	1,2	128/82	188/82
100	4	160	215	29	55	0,77	1,7	158/105	213/105
125	5	190	275	32	50	1,2	3	188/130	273/130
150	6	215	330	34	50	1,7	4,8	213/155	328/155
200	8	275	380	39	50	2,7	6,6	273/205	376/205
250	10	330	440	44	53	3,8	9,2	328/255	436/255
300	12	380	490	49	54	5,2	12	376/310	486/310
350	14	440	540	54	50	7,5	15	436/360	536/360
400	16	490	595	54	50	9	18	486/410	591/410
450	18	540	695	54	53	11	25	536/460	691/460
500	20	595	695	54	50	13	25	591/510	691/460
600	24	695	790	54	50	16	27	691/610	786/610



# TRACEABILITY, MARKINGS AND CODING

## TRACEABILITY AND MARKING

ON BURSTING DISCS HOLDERS WITH REMOVABLE MEMBRANES, THE LABEL INDICATES :

- Mersen serial number
- The nominal diameter of the disc or the associated membrane
- The coupling type
- The tightening torque
- The bursting direction
- The manufacturing year

ON SINGLE-PIECE BURSTING DISCS, THE LABEL INDICATES :

- Mersen serial number
- The nominal diameter
- The graphite batch number
- The year of manufacture
- The specified burst pressure calibrated at 20°C
- The tolerance on PRS
- The temperature for which the burst pressure is specified
- The coupling type
- The tightening torque
- The CE marking (for burst pressure > = 0.50 bar)
- The standard used
- The PED fluid group
- The burst direction



## CODING

Each disc has a reference code. This code is composed of 12 alphanumeric characters, as defined below :

--/--/---/----- = Disc/Series/Diameter/Pressure

Disc example n°0120150-1000

01 = disc / 20 = Series 2/ 150 = diameter 150 / 1000 = 10 bars of maximum pressure

Disc example n°0140-50--035

01 = disc / 40 = Series 4/ -50 = diameter 50 / --035 = 0.35 bars of maximum pressure

# TECHNICAL INFORMATION

## ASSEMBLY OF BURSTING DISCS

The installation and commissioning manual supplied with each disc summarizes the installation and utilization instructions.

## MOST COMMON ASSEMBLY EXAMPLES

### PROTECTION OF SAFETY VALVE :

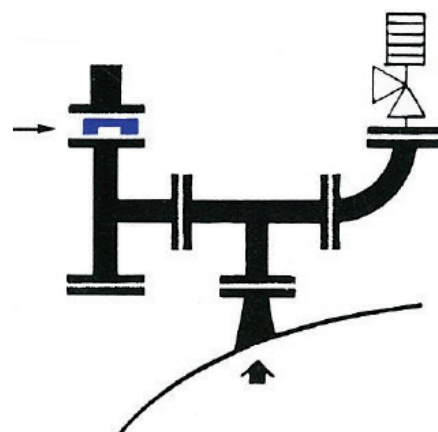
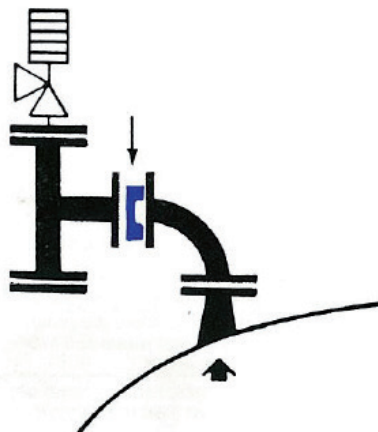

#### ■ IN SERIES

- The specified burst pressure of the disc should be more than the opening pressure set for the valve.
- The safety valve would operate after the bursting of the safety disc.
- Warning : put a safety basket to protect the valve of fragments of graphite.

#### ■ IN PARALLEL

- The specified burst pressure of the disc should be higher than the opening pressure of the valve.
- The safety disc operates only when the safety valve fails.

### PROTECTION AGAINST OVERPRESSURE AND NEGATIVE PRESSURE :

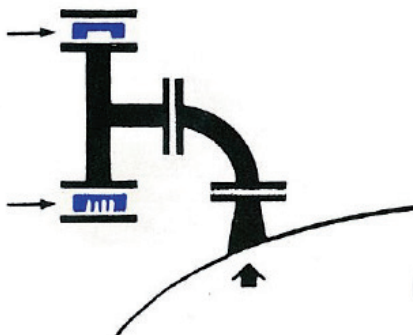

- The upper disc insures the protection against over-pressure.
- The lower disc insures the protection against negative pressure.

# BURSTING DISCS IN GRAPHILOR®3 SERIES 1

## DISCS WITH REMOVABLE MEMBRANES

- Low pressure use
- DN 50 to 600
- PN 10-16
- Holder sold separately
- Vacuum grid integrated in holder

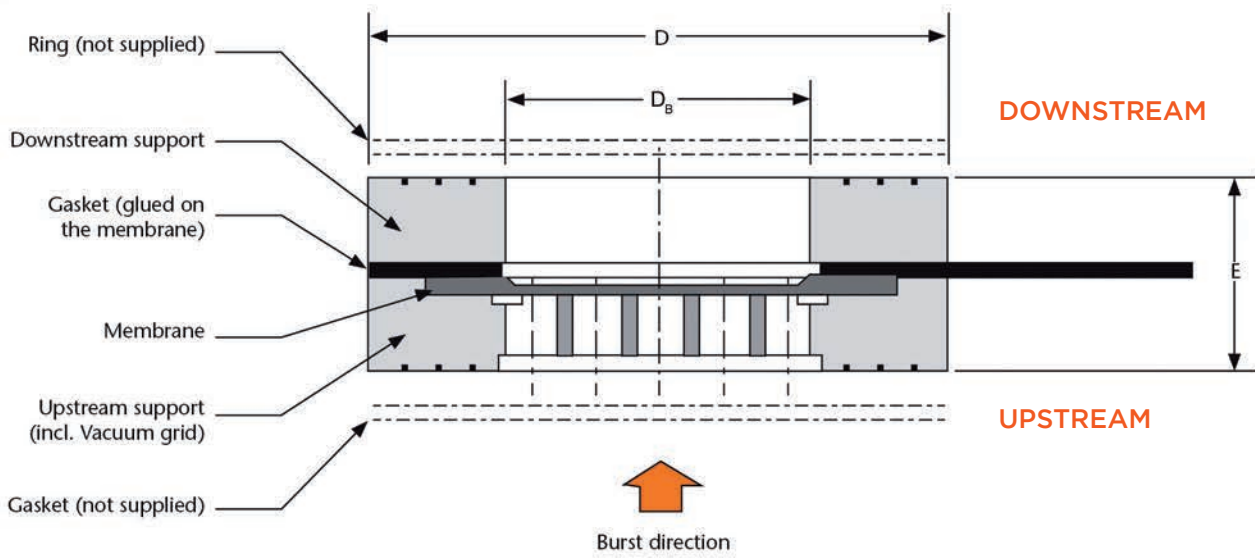

### SERIES 1 - FEATURES

DN (DISCHARGE Ø) - D <sub>B</sub> -		PN	ANSI	GASKET OD/ID	WEIGHT	2 HOLDERS WEIGHT	OD - D -	TOTAL THICKNESS - E -	DISCHARGE CROSS SECTION	*MIN BURST PRESSURE - PR - (1)	*MAX BURST PRESSURE - PR - (1)
mm	inch	bar	Lbs	mm	kg	kg	mm	mm	cm	barg	barg
50	2"	10-16	150	98/52	0,25	0,35	100	32	8,6	0,2	0,34
65	2" ½	10-16	150	113/67	0,03	0,45	115	32	17,6	0,2	0,34
80	3"	10-16	150	128/82	0,04	0,55	130	32	21,6	0,15	0,34
100	4"	10-16	150	158/105	0,08	0,75	160	32	43,2	0,15	0,34
150	6"	10-16	150	213/155	0,17	1,20	215	32	70,7	0,07	0,34
200	8"	10	150	273/205	0,32	2,50	275	45	157,1	0,07	0,34
250	10"	10	150	328/255	0,50	5,20	330	65	260,2	0,07	0,34
300	12"	10	150	376/310	0,65	8	380	81	381,7	0,07	0,34
350	14"	10	150	436/360	1,30	12	440	103	481,1	0,07	0,34
400	16"	10	150	486/410	1,80	14	490	103	628,3	0,07	0,34
450	18"	10	150	536/460	2,70	20	540	123	842,9	0,07	0,34
500	20"	10	150	591/510	3,60	23	595	123	981,7	0,07	0,34
600	24"	10	150	691/610	6,50	26	695	123	1413,7	0,07	0,34

(\* ) The specified burst pressure is calibrated at 20°C

# BURSTING DISCS IN GRAPHILOR®3 SERIES 2

## DISCS WITH REMOVABLE MEMBRANES

- Medium pressure use
- DN 25 to 600
- PN 10-16-25-40
- Holder and vacuum grid sold separately

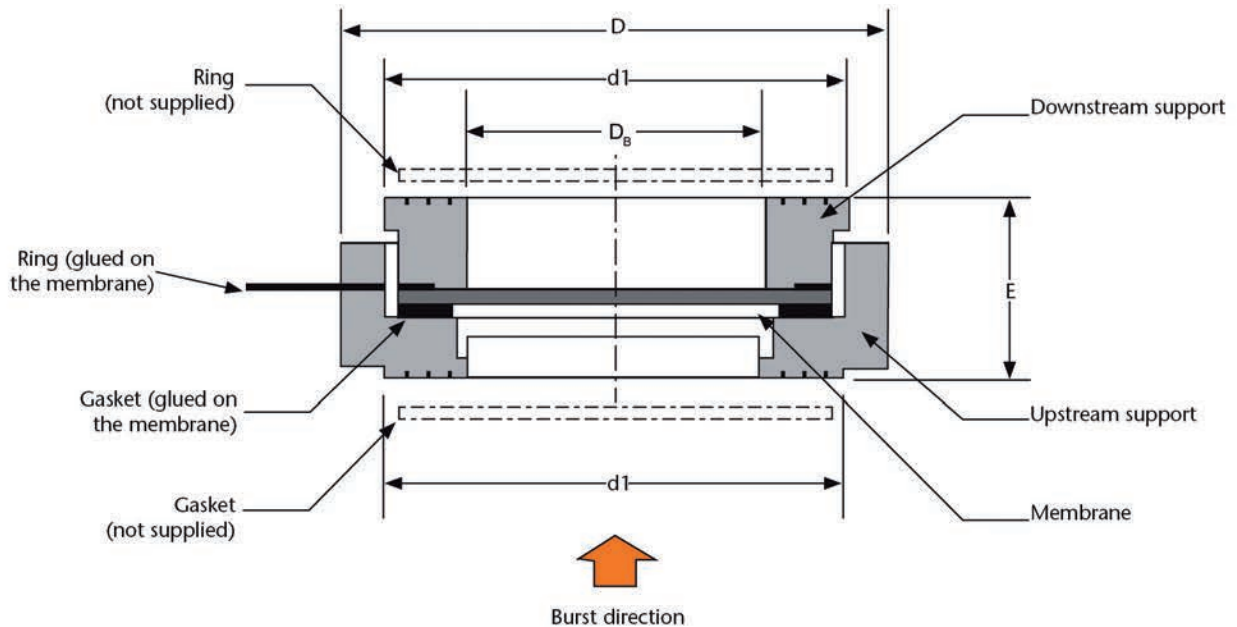

On request, the upstream support can be equipped with a grid to allow operation under vacuum

### SERIES 2 - FEATURES

DN (DISCHARGE Ø) - D <sub>B</sub> -		PN	ANSI SERIE	GASKET OD/ID	MEMBRANE WEIGHT AT PR MIN	MEMBRANE WEIGHT AT PR MAX	2 HOLDERS WEIGHT	OD - D -	- d1 -	MIN TOTAL THICKNESS - E -	MAX TOTAL THICKNESS - E -	DISCHARGE CROSS SECTION	DISCHARGE CROSS SECTION WITHOUT GRID	*MIN BURST PRESSURE - PR - (1)	*MAX BURST PRESSURE - PR - (1)
mm	inch														
25	1"	10-16-25-40	300	54/27	0,005	0,013	0,1	65	56	25	28	2,5	5,0	0,80	30
40	1½"	10-16-25	300	67/42	0,005	0,02	0,15	80	68	27	32	6,4	11,4	0,50	20
50	2"	10-16-25	300	76/52	0,008	0,04	0,25	100	78	29	33	10,8	20,4	0,35	15
65	2½"	10-16	150	92/67	0,012	0,06	0,3	115	94	33	38	17,6	31,8	0,35	12
80	3"	10-16	150	108/82	0,020	0,09	0,45	130	110	37	42	31,7	45,8	0,35	10
100	4"	10-16	150	140/105	0,032	0,19	0,8	160	140	43	49	47,1	81,4	0,35	8
125	5"	10-16	-	170/130	0,095	0,3	1,3	190	175	50	58	74,9	127,3	0,35	6
150	6"	10-16	150	200/155	0,11	0,57	1,7	215	200	56	65	106,0	183,1	0,35	6
200	8"	10	150	260/205	0,22	1	3,5	275	260	75	85	188,5	352,9	0,35	4
250	10"	10	150	315/255	0,45	1,8	5,8	330	320	95	115	284,7	509,1	0,35	3
300	12"	10	150	368/310	0,9	2,4	8	380	375	110	125	395,8	733,1	0,35	2,5
350	14"	10	150	425/360	1,4	3,4	13	445	435	125	145	577,3	998,2	0,35	2
400	16"	10	150	480/410	2	4,5	17	500	490	150	170	716,3	1303,6	0,35	1,5
450	18"	10	150	533/460	2,7	6,2	24	560	545	180	195	922,5	1648,6	0,35	1,5
500	20"	10	150	588/510	3,5	7,6	34	620	600	205	220	1138,8	2034,8	0,35	1,2
600	24"	10	150	698/610	7	14	58	710	710	265	280	1583,4	2933,0	0,35	1,5

(\* ) The specified burst pressure is calibrated at 20°C

# BURSTING DISCS IN GRAPHILOR® 3 SERIES 3

## SINGLE-PIECE DISCS

- Medium pressure use
- DN 25 to 600
- PN 10-16-25-40
- Does not work under vacuum

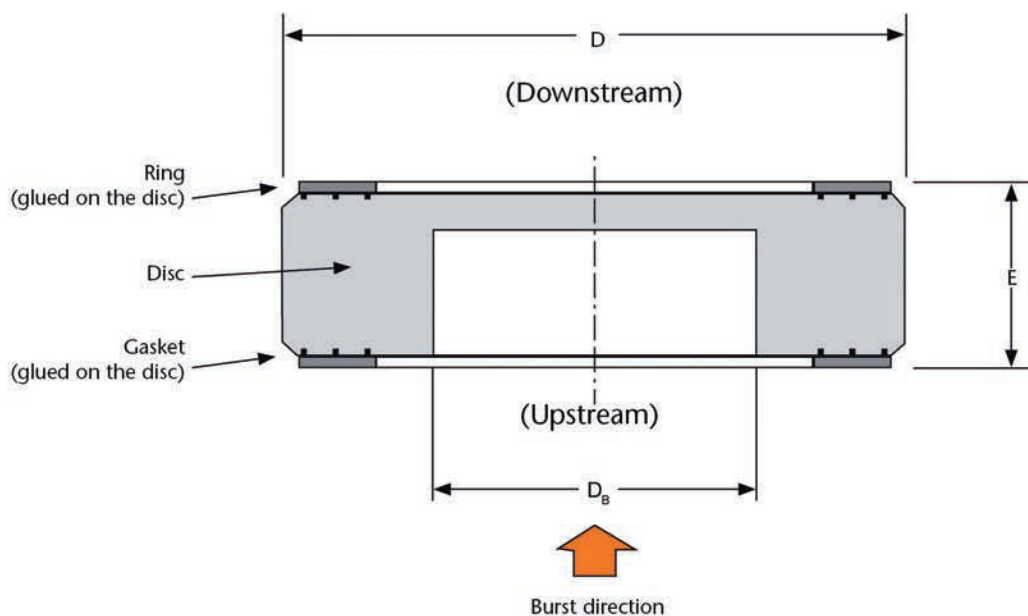

### SERIES 3 - FEATURES

DN (DISCHARGE Ø) - D <sub>B</sub> -		PN	ANSI SERIE	GASKET OD/ID	WEIGHT AT PR MIN	WEIGHT AT PR MAX	OD - D -	MAX TOTAL THICKNESS - E -	DISCHARGE CROSS SECTION	*MIN BURST PRESSURE - PR - (1)	*MAX BURST PRESSURE - PR - (1)
mm	inch	bar	Lbs	mm	kg	kg	mm	mm	cm <sup>2</sup>	barg	barg
25	1"	10-16-25-40	300	63/44	0,11	0,12	65	22	4,9	2,50	40
40	1½"	10-16-25-40	300	78/60	0,15	0,17	80	23	12,6	1,50	35
50	2"	10-16-25-40	300	98/79	0,25	0,28	100	24	19,6	1	30
65	2½"	10-16-25	300	113/90	0,30	0,4	115	26	33,2	0,80	25
80	3"	10-16-25	150	128/107	0,40	0,50	130	27	50,3	0,50	20
100	4"	10-16	150	158/137	0,63	0,80	160	29	78,5	0,40	15
125	5"	10-16	-	188/165	0,85	1,10	190	32	122,7	0,30	12
150	6"	10-16	150	213/184	1,20	1,4	215	34	176,7	0,30	10
200	8"	10	150	273/240	2,20	3,4	275	39	314,2	0,2	8
250	10"	10	150	328/298	3,20	4,1	330	44	490,9	0,15	6
300	12"	10	150	376/348	4,40	6	380	49	706,9	0,15	4
350	14"	10	150	436/390	5,60	9,3	440	54	962,1	0,10	2,5
400	16"	10	150	486/450	6,40	11	490	54	1256,6	0,10	2
450	18"	10	150	536/494	8	13	540	54	1590,4	0,10	1,5
500	20"	10	150	591/545	9	16	595	54	1963,5	0,08	1,5
600	24"	10	150	691/648	12	21	695	54	2827,4	0,08	1,2

(\* ) The specified burst pressure is calibrated at 20°C

# BURSTING DISCS IN GRAPHILOR®3 SERIES 4

## SINGLE-PIECE DISCS

- Medium pressure use
- DN 25 to 600
- PN 10-16-25-40
- Holder and vacuum grid sold separately

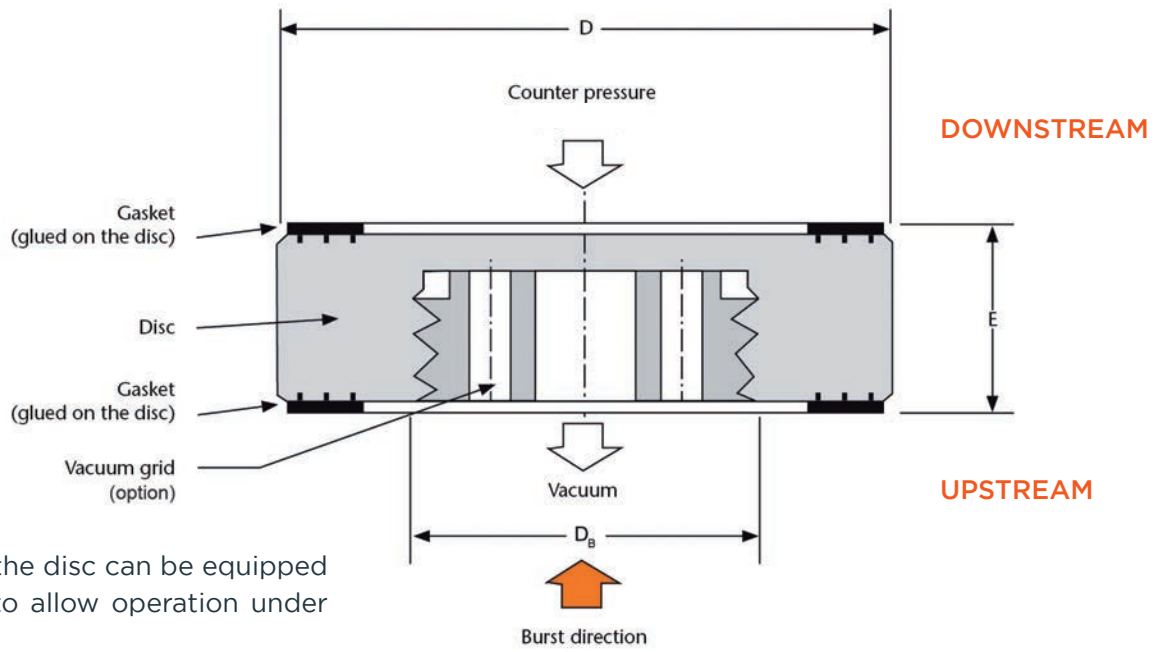

On request, the disc can be equipped with a grid to allow operation under vacuum

### SERIES 4 - FEATURES

DN (DISCHARGE Ø) - D <sub>b</sub> -		PN	ANSI SERIE	GASKET OD/ID	WEIGHT AT PR MIN	WEIGHT AT PR MAX	OD - D -	MAX TOTAL THICKNESS - E -	DISCHARGE CROSS SECTION	*MIN BURST PRESSURE - PR - (1)	*MAX BURST PRESSURE - PR - (1)
mm	inch	bar	Lbs	mm	kg	kg	mm	mm	cm <sup>2</sup>	barg	barg
25	1"	10-16-25-40	300	63/44	0,12	0,13	65	22	2,5	2,50	40
40	1½"	10-16-25-40	300	78/60	0,17	0,19	80	23	6,4	1,50	35
50	2"	10-16-25-40	300	98/79	0,28	0,3	100	24	10,8	1	30
65	2½"	10-16-25	300	113/90	0,35	0,45	115	26	17,6	0,80	25
80	3"	10-16-25	150	128/107	0,49	0,59	130	27	31,7	0,50	20
100	4"	10-16	150	158/137	0,83	0,98	160	29	47,1	0,40	15
125	5"	10-16	-	188/165	1,20	1,40	190	32	74,9	0,35	12
150	6"	10-16	150	213/184	1,60	1,8	215	34	106,0	0,35	10
200	8"	10	150	273/240	3,00	4,2	275	39	188,5	0,35	8
250	10"	10	150	328/298	4,80	5,7	330	44	284,7	0,35	6
300	12"	10	150	376/348	6,70	8,3	380	49	395,8	0,35	4
350	14"	10	150	436/390	9,60	13	440	54	577,3	0,35	2,5
400	16"	10	150	486/450	12	17	490	54	716,3	0,35	2
450	18"	10	150	536/494	15	20	540	54	922,5	0,35	1,5
500	20"	10	150	591/545	16	23	595	54	1138,8	0,35	1,5
600	24"	10	150	691/648	24	33	695	54	1583,4	0,35	1,2

(\* ) The specified burst pressure is calibrated at 20°C



# BURSTING DISCS IN GRAPHILOR®3 SERIES 5

## SINGLE-PIECE DISCS

- High pressure use
- DN 25 to 600
- PN 10-16-25-40-50-100
- Does not work under vacuum

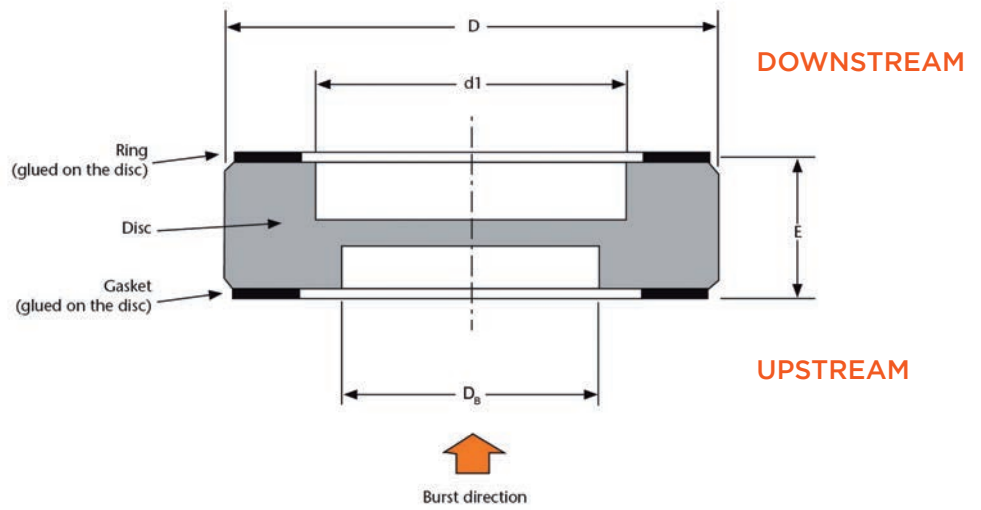

### SERIES 5 - FEATURES

DN (DISCHARGE Ø) - D <sub>B</sub>		PN	ANSI SERIE	GASKET OD/ID	WEIGHT AT PR MIN	WEIGHT AT PR MAX	OD - D -	- d1 -	MAX TOTAL THICKNESS - E -	DISCHARGE CROSS SECTION	*MIN BURST PRESSURE - PR - (1)	*MAX BURST PRESSURE - PR - (1)
mm	inch	bar	Lbs	mm	kg	kg	mm	mm	mm	cm	barg	barg
25	1"	50-100	600	98/52	0,34	0,35	100	55	39	4,9	40	100
40	1½"	50-100	300-600	128/82	0,60	0,62	130	80	42	12,6	40	100
40	1½"	25-40	300-600	128/82	0,60	0,62	130	80	42	12,6	-	40
50	2"	100	300-600	158/105	1,2	1,3	160	100	44	19,6	40	80
50	2"	25-40	300	158/105	1,2	1,3	160	100	44	19,6	-	40
65	2½"	100	300	188/130	2,1	2,2	190	125	48	33,2	50	60
65	2½"	25-40	150-300	188/130	2,1	2,2	190	125	48	33,2	-	40
80	3"	50	150-300	188/130	2,3	2,4	190	125	51	50,3	25	50
80	3"	25-40	150	188/130	2,3	2,4	190	125	51	50,3	-	25
100	4"	25-40	150	213/155	2,6	2,9	215	150	54	78,5	15	40
125	5"	40	-	273/205	5,2	5,3	275	200	57	122,7	25	30
125	5"	25	-	273/205	5,2	5,3	275	200	57	122,7	16	25
125	5"	16	-	273/205	5,2	5,3	275	200	57	122,7	-	16
150	6"	25	150	328/255	8,1	8,2	330	250	60	176,7	16	25
150	6"	16	150	328/255	8,1	8,2	330	250	60	176,7	-	16
200	8"	16	150	376/310	10	10	380	300	70	314,2	10	15
200	8"	10	150	376/310	10	10	380	300	70	314,2	-	10
250	10"	16	150	436/360	18	18	440	350	76	490,9	10	15
250	10"	10	150	436/360	18	18	440	350	76	490,9	-	10
300	12"	16	150	486/410	23	24	490	400	86	706,9	10	12
300	12"	10	150	486/410	23	24	490	400	86	706,9	-	10
350	14"	10	150	536/460	25	29	540	450	95	962,1	2,5	10
400	16"	10	150	591/510	30	35	565	500	102	1256,6	2	10
450	18"	10	150	691/605	40	54	695	600	114	1590,4	1,5	8
500	20"	10	150	691/605	42	58	695	600	127	1963,5	1,5	8
600	24"	10	150	786/705	56	83	790	700	152	2827,4	1,2	6

(\* ) The specified burst pressure is calibrated at 20°C

# BURSTING DISCS IN GRAPHILOR®3 SERIES 6

## SINGLE-PIECE DISCS WITH PFA PROTECTION

- Medium pressure use
- DN 25 to 600
- PN 10-16-25-40
- For high corrosive fluids
- Does not work under vacuum

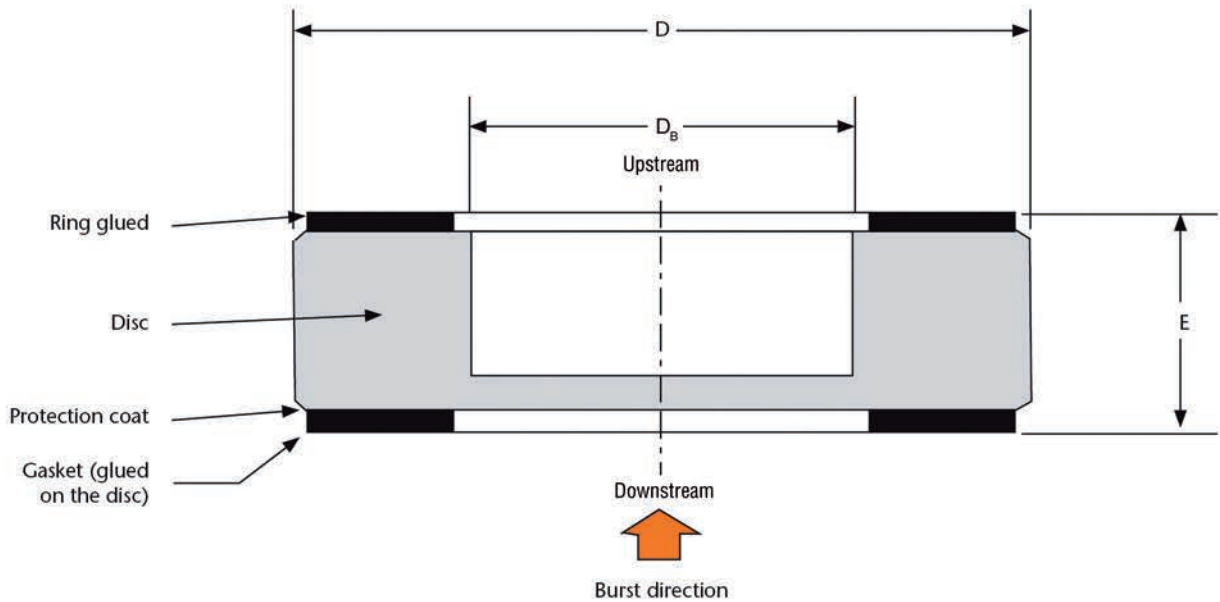

### SERIES 6 - FEATURES

DN (DISCHARGE Ø) - D <sub>B</sub> -		PN	ANSI SERIE	GASKET OD/ID	WEIGHT AT PR MIN	WEIGHT AT PR MAX	OD - D -	MAX TOTAL THICKNESS - E -	DISCHARGE CROSS SECTION	*MIN BURST PRESSURE - PR - (1)	*MAX BURST PRESSURE - PR - (1)
mm	inch										
25	1"	10-16-25-40	300	63/27	0,11	0,12	65	22	4,9	4	35
40	1½"	10-16-25-40	300	78/42	0,14	0,15	80	23	12,6	2,5	30
50	2"	10-16-25-40	300	98/52	0,24	0,26	100	24	19,6	1,5	25
65	2½"	10-16-25	150	113/67	0,28	0,37	115	26	33,2	1	20
80	3"	10-16-25	150	128/82	0,36	0,45	130	27	50,3	0,80	15
100	4"	10-16	150	158/105	0,66	0,75	160	29	78,5	0,50	12
125	5"	10-16	-	188/130	0,88	1	190	32	122,7	0,40	10
150	6"	10-16	150	213/155	1,05	1,2	215	34	176,7	0,30	8
200	8"	10	150	273/205	1,90	3	275	39	314,2	0,30	6
250	10"	10	150	328/255	2,80	3,6	330	44	490,9	0,20	5
300	12"	10	150	376/310	3,80	5,3	380	49	706,9	0,15	3,5
350	14"	10	150	436/360	5	8,5	440	54	962,1	0,15	2
400	16"	10	150	486/410	6	9	490	54	1256,6	0,1	1,5
450	18"	10	150	536/460	7	12	540	54	1590,4	0,1	1,5
500	20"	10	150	591/510	8	14	595	54	1963,5	0,1	1,2
600	24"	10	150	691/604	11	18	695	54	2827,4	0,1	1,2

(\* ) The specified burst pressure is calibrated at 20°C

# BURSTING DISCS IN GRAPHILOR®3 SERIES 7

## BURST PLUG

- Low flow use
- Diameter 12.7 to 19mm
- Height 32 to 50 mm
- Brass or stainless steel holder sold separately

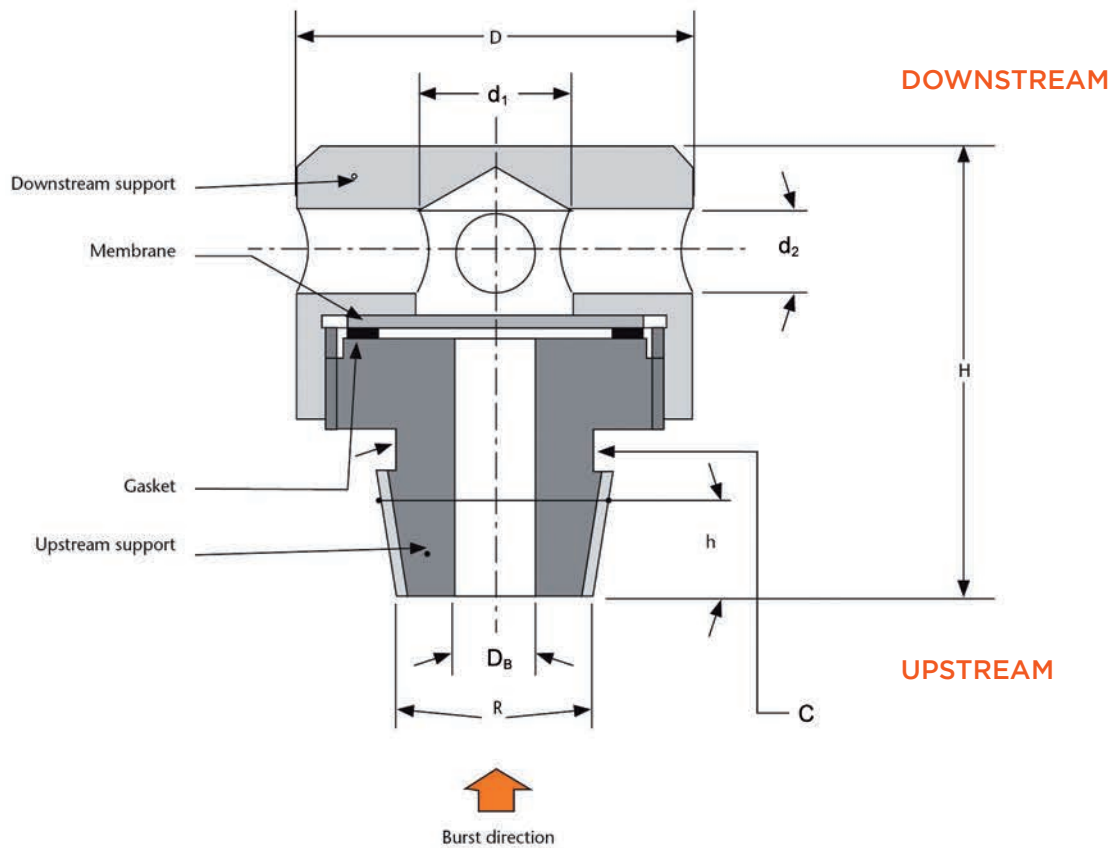

### SERIES 7 - FEATURES

DN (EFFECTIVE Ø) - D1 -		GASKET OD/ID	OD - D -	DIA. - d <sub>2</sub> -	DIA. - D <sub>B</sub> -	- R -	- h -	- C -	TOTAL HEIGHT - H -	DISCHARGE CROSS SECTION	*MIN BURST PRESSURE - PR - (1)	*MAX BURST PRESSURE - PR - (1)
mm	inch	mm	mm	mm	mm	inch	mm	mm	mm	cm <sup>2</sup>	barg	barg
12,7	1/2"	23/15	32	5,5	6,35	1/2"	8	17	32	0,32	3	80
19	3/4"	28,5/22	38	9,5	12,7	3/4"	9,5	24	50	1,27	1,4	50

(\*) The specified burst pressure is calibrated at 20°C

# BURSTING DISCS IN GRAPHILOR®3 SERIES 8

## SINGLE-PIECE DISCS WITH PFA PROTECTION

- Medium pressure use
- DN 25 to 600
- PN 10-16-25-40
- For high corrosive fluids
- Does not work under vacuum

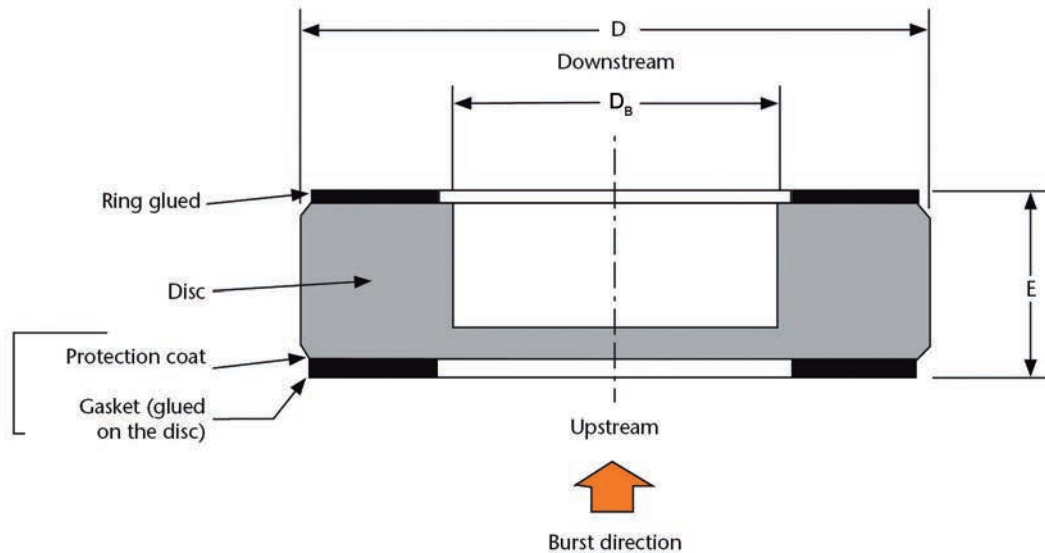

The bursting discs in series 8 can operate in a vacuum if the burst pressure is above 1.2 barg.

### SERIES 8 - FEATURES

DN (DISCHARGE Ø) - D <sub>B</sub> -		PN	ANSI SERIE	GASKET OD/ID	WEIGHT AT PR MIN	WEIGHT AT PR MAX	OD - D -	MAX TOTAL THICKNESS - E -	DISCHARGE CROSS SECTION	*MIN BURST PRESSURE - PR - (1)	*MAX BURST PRESSURE - PR - (1)
mm	inch										
25	1"	10-16-25-40	300	63/27	0,11	0,12	65	22	4,9	2,5	40
40	1½"	10-16-25-40	300	78/42	0,15	0,17	80	23	12,6	1,5	35
50	2"	10-16-25-40	300	98/52	0,25	0,28	100	24	19,6	1	30
65	2½"	10-16	300	113/67	0,30	0,4	115	26	33,2	0,80	25
80	3"	10-16-25	150	128/82	0,40	0,5	130	27	50,3	0,50	20
100	4"	10-16	150	158/105	0,63	0,8	160	29	78,5	0,40	15
125	5"	10-16	-	188/130	0,85	1,1	190	32	122,7	0,30	12
150	6"	10-16	150	213/155	1,2	1,4	215	34	176,7	0,30	10
200	8"	10	150	273/205	2,2	3,4	275	39	314,2	0,20	8
250	10"	10	150	328/255	3,2	4,1	330	44	490,9	0,15	6
300	12"	10	150	376/310	4,4	6	380	49	706,9	0,10	4
350	14"	10	150	436/360	5,6	9,3	440	54	962,1	0,10	2,5
400	16"	10	150	486/410	6,4	11	490	54	1256,6	0,10	2
450	18"	10	150	536/460	8	13	540	54	1590,4	0,10	1,5
500	20"	10	150	591/510	9	16	595	54	1963,5	0,08	1,5
600	24"	10	150	691/604	12	21	695	54	2827,4	0,08	1,2

(\* ) The specified burst pressure is calibrated at 20°C

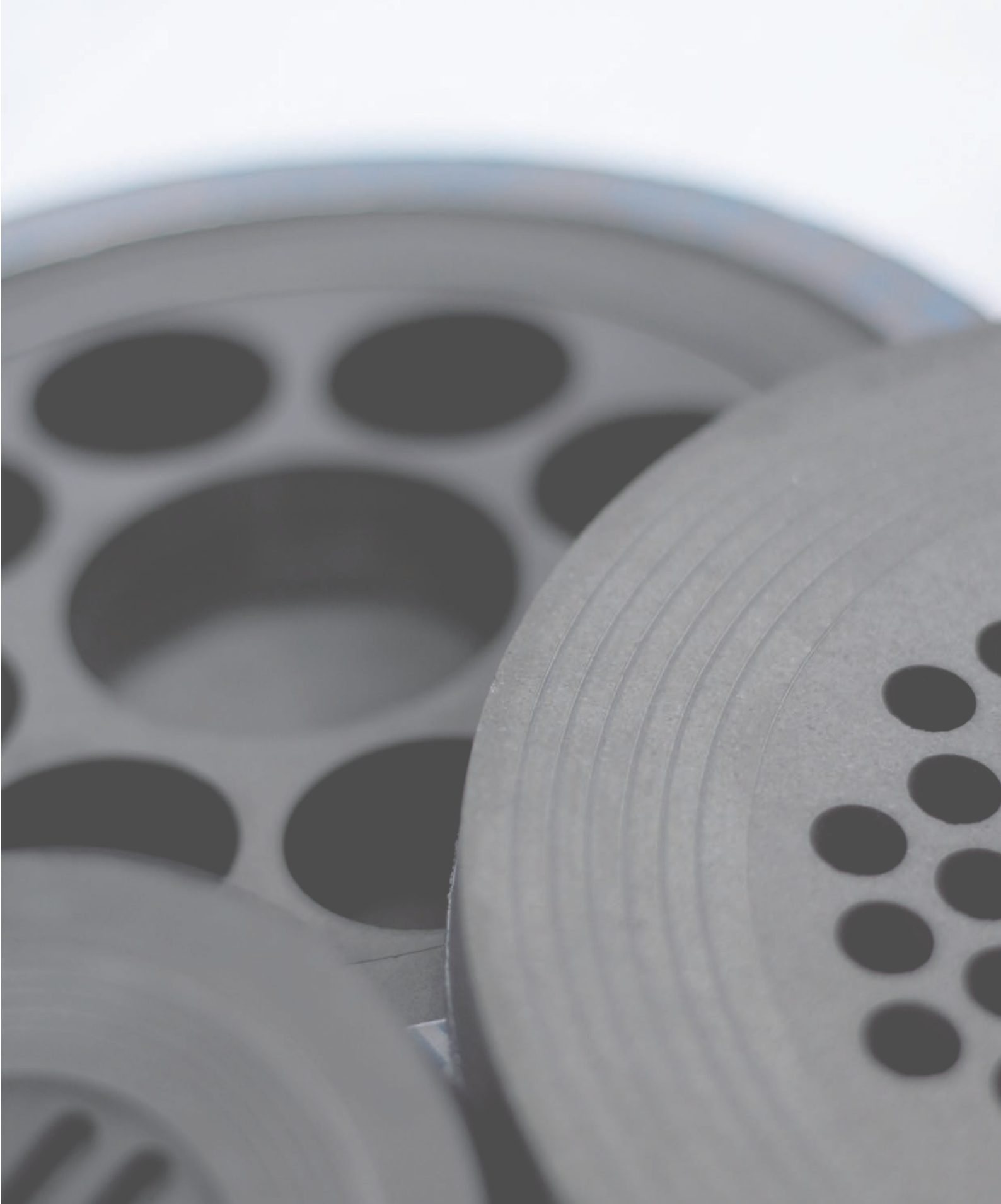

The specification or data herein contained are only given for indication, without any undertakings whatsoever. Their publication does not suggest the matter is free of any rights whatsoever. Furthermore, due to constant evolution of techniques and norms, we reserve the right to modify, at any time, the characteristics and specifications contained in this document. MERSEN refuses all and any responsibility concerning their use whatever the purpose or application. Any copy, reproduction or information herein contained, in whole or in part, made without MERSEN written consent, is forbidden according to the laws of France and particularly the law nr. 92-597 of July 1st 1992 relating to the copyright.



GLOBAL EXPERT IN ELECTRICAL  
POWER AND ADVANCED MATERIALS

**EUROPE**

**FRANCE**

Mersen France Py S.A.S.  
Tel : +33 (0)3 83 81 60 81  
info.pagny@mersen.com

**GERMANY**

Mersen Deutschland  
Linsengericht GmbH  
Tel : +49 (0) 6051 71 037  
info.lsg@mersen.com

**ITALIA**

Mersen Italia S.p.A.  
Tel : +39 02 82 681 31  
ace.italia@mersen.com

**SPAIN**

Mersen Iberica fma, S.A.  
Tel : +34 93 685 7800  
contact.iberica@mersen.com

**THE NETHERLANDS**

Mersen Benelux B.V.  
Tel : +31(0)10 298 30 30  
contact.schiedam@mersen.com

**UNITED KINGDOM**

Mersen UK Teesside Ltd.  
Tel : +44 (0)1642 790100  
ace.uk@mersen.com

**RUSSIA & EASTERN EUROPE**

Tel : +7 (964) 768 14 05  
info.pagny@mersen.com

**TURKEY**

Mersen Istanbul San. Ür. A. Ş.  
Tel : +90 262 751 0262  
sales.istanbul@mersen.com

**ASIA**

**CHINA**

Mersen XIANDA  
Tel : +86 21 5752 7777  
info.xianda@mersen.com

**INDIA**

Mersen India  
Tel : +91 9845331292  
/+91 9840078844  
sales.ace.india@mersen.com

**JAPAN**

MERSEN FMA JAPAN K.K.  
Tel : +81 (3) 5368-3250  
ace.japan@mersen.com

**KOREA**

Mersen Korea Co., Ltd.  
Tel : +82 (0)2 598 0071  
sales.korea@mersen.com

**SOUTH EAST ASIA**

Tel : +91 9500041487  
graphite.sales@framet.com

**NORTH AMERICA**

**USA**

Mersen USA Salem  
Tel : +1 540 389-7535  
sales.salem@mersen.com

**Mersen USA Gonzales**

Tel : +1 225 647-6752  
graphiterepairs.gonzales@mersen.com

**AFRICA**

**MOROCCO**

Mersen Maroc S.A.R.L.  
Tel : + 212 (0) 523 38 30 12  
contact.maroc@mersen.com

**SOUTH AFRICA**

Mersen South Africa, (Pty) Ltd.  
Tel : +27 011 474 0000  
marketing.za@mersen.com

**MIDDLE EAST & AFRICA**

Tel : +33 (0)3 83 81 60 81  
Info.pagny@mersen.com

**SOUTH AMERICA**

**ARGENTINA**

Mersen Argentina, S.A.  
Tel : +54 11 49 18 21 21  
infos.latam@mersen.com

**BRAZIL**

Mersen Do Brasil, Ltda.  
Tel : +55 (11) 4529 1160  
vendas.ace.brasil@mersen.com

**CHILE**

Mersen Chile  
Tel : +56 22 621 5680  
ventas.chile@mersen.com

**COLOMBIA**

Mersen Colombia  
Tel : +57 (1) 3684588  
ace.latam@mersen.com

**MEXICO & LATIN AMERICA**

Mersen Mexico Monterrey  
Tel : +52 (81) 8127 2812  
ace.latam@mersen.com

